

TechViz

VIRTUAL PROTOTYPE

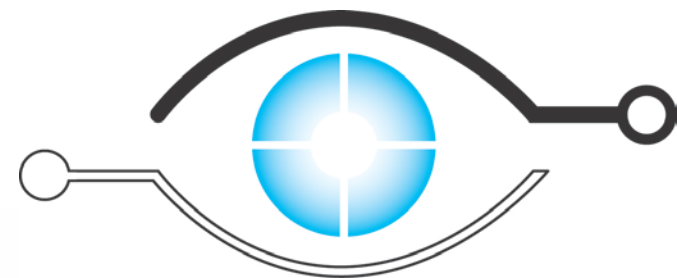

TechViz

www.techviz.net

Virtual Prototyping

- From Product Design to VP



Product design

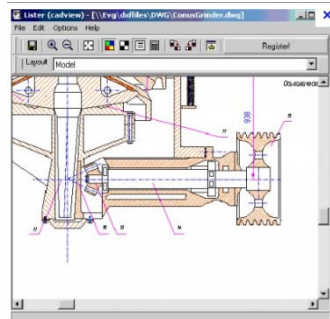

2D

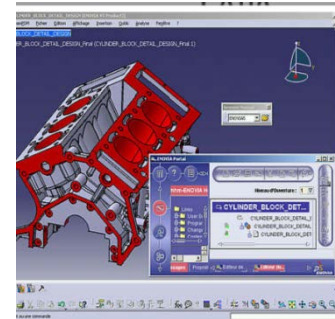

3D



Virtual Reality
Collaboration

Definition

The ability to virtually explore a complete product before conception.
Technique in the process of product development Using CAD software.
Validate a design before committing to making a physical prototype.



Visualization to boost decisions making

Different approaches

Clay Modeling

- 👎 Cost
- 👎 External provider
- 👎 4 weeks delay
- 👎 Modification time
- ✅ High quality



Virtual Reality (*import*)

- ✅ Cost
- 👎 Dedicated team
- 👎 Days delay
- 👎 Modification needs conversion, development, etc...
- ✅ Good quality

Virtual Reality *TechViz*

- ✅ Cost
- ✅ No specific team
- ✅ Immediate visualization
- ✅ Immediate modification
- ✅ Good quality



TechViz

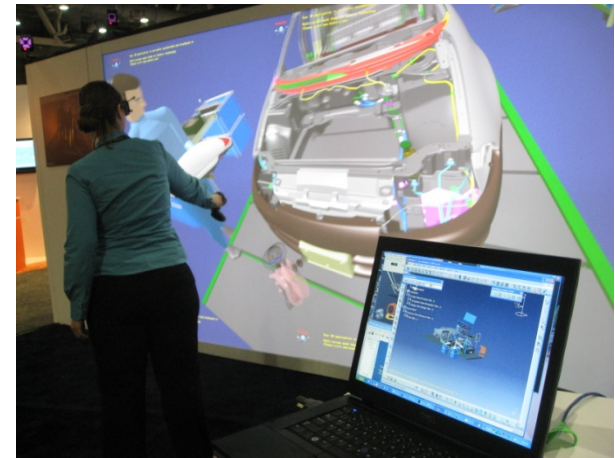
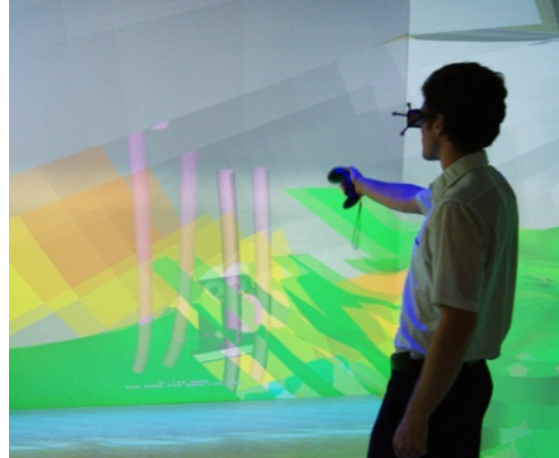

Founded in 2004
Headquarter and R&D
Located in Paris



Software editor

🔧 Provider in advanced
visualization solutions

🔧 For 3D applications

Cutting edge technology

R&D experts in:

🔧 Computer architecture

🔧 3D rendering

🔧 Cluster computing

🔧 Virtual Reality



References



LAING O'ROURKE
WALT DISNEY
Imagineering

Architecture & Construction



IIT Madras
IIT Bombay
DCNS
BNS

Shipbuilding



FENDT
KOMATSU
CLAAS
ALSTOM

Industry & Manufacturing



VW
PORSCHE
RENAULT
BMW
PSA PEUGEOT CITROËN
TOYOTA
DAIMLER
MAGNA STEYR

Automotive



BEIJING INSTITUTE
KAUST
WRIGHT STATE
UNIVERSITY
KIT
Harbin University of Science and Technology

Research



LOCKHEED MARTIN
CNES
DASSAULT
AVIATION
Alenia Aeronautica
AVIC

Aeronautics



EDF
ارامكو السعودية
Saudi Aramco
Keppel FELS
BR
PETROBRAS

Energy, Oil & Gas



References

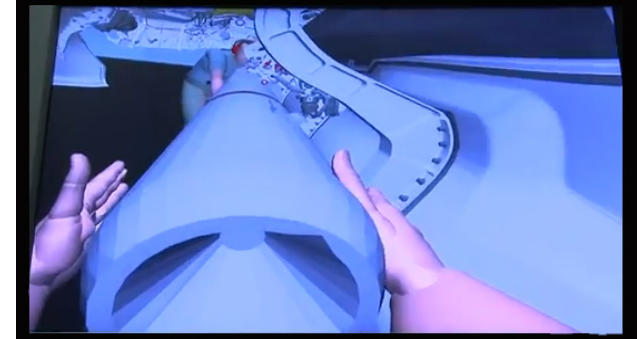
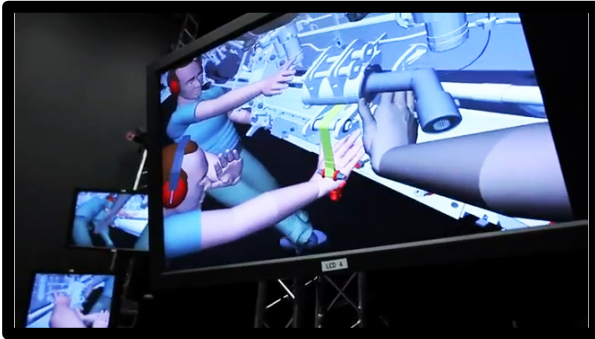

- 🕒 Check comfort and ergonomics
- 🕒 Check design towards safety requirements
- 🕒 Training
- 🕒 Inter-disciplinary project review
- 🕒 VIP presentations for sales and marketing



Products

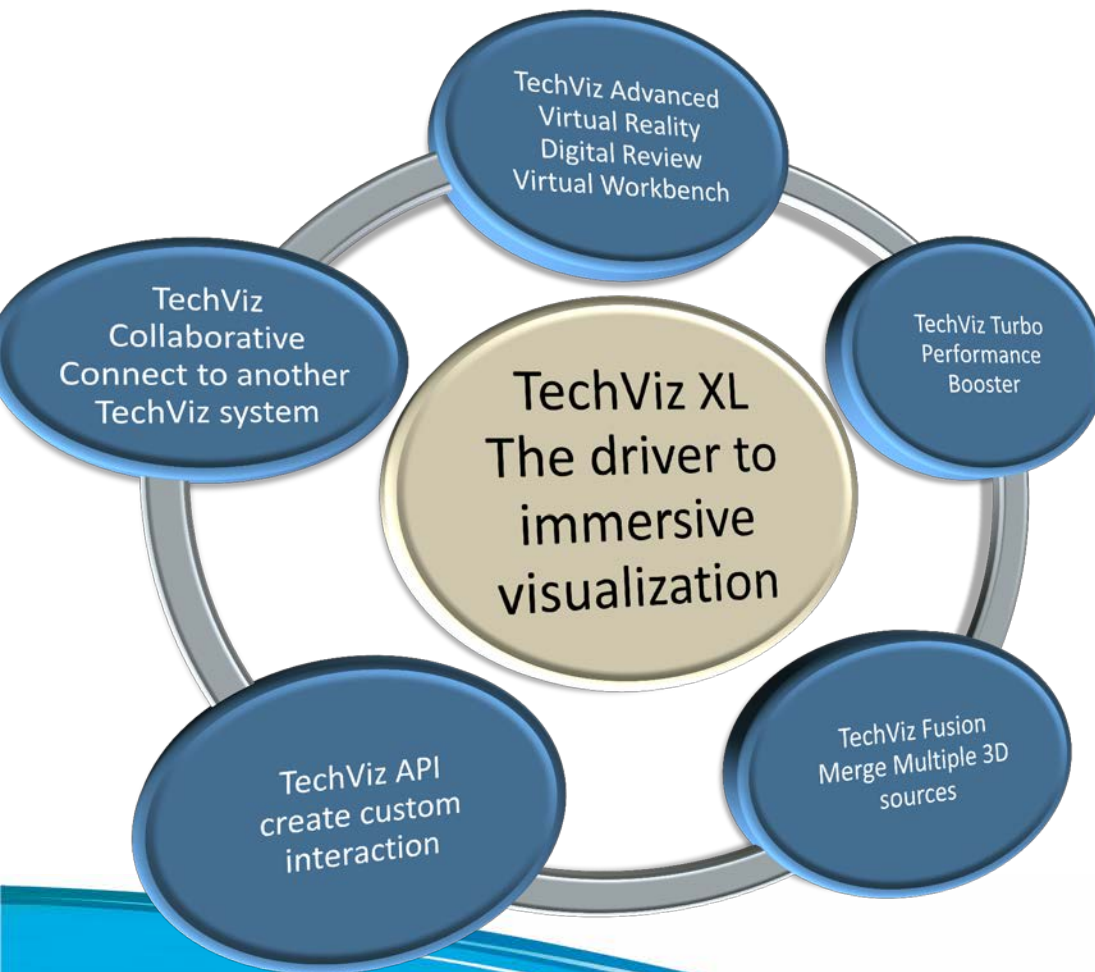

TechViz Added Value

Powers up your 3D applications

- 👁 Immersive Visualization
- 👁 Allows Large Scale Visualization (multiple channel)
- 👁 Allows PC clustering
- 👁 Improves Graphic Performances

Display Directly from native 3D application

Easy and Sheer Immersive Visualization



Scalable Platform

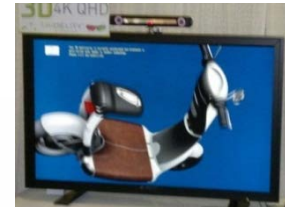

TechViz

TechViz Virtual Workbench Demo



TechViz Overview



Over 150 certified 3D applications

By vendor				By application field			
<i>DASSAULT SYSTEMES</i>	<i>Autodesk</i>	<i>PTC</i>	<i>AVEVA</i>	<i>CAD</i>	<i>VR/Simulation</i>	<i>CAE/CAM</i>	<i>3D Toolkits</i>
3DVia Composer Player 3DXML Player	3ds Max Alias	CoCreate Product View	PDMS Review	Lumiscaphe Patchwork 3D Rhino 3D	Eon Studio BSContact Presagis Vega Prime	RecurDyn Fluent	OGRE XJ3D SGI OpenGL Performer
Abaqus CATIA V5 CATIA V6	AutoCAD Image Studio Inventor	Pro/Engineer Division 2000i2	Tribon Marine	MAXXON Cinema 4D AC3D Blender	Disti GL Studio Walkinside Dolphinity Racer	FieldView KineoCam Path Planner GNS Animator	VSG OpenInventor OpenSceneGraph
Enovia DMU Delmia Seemage	Maya MotionBuilder Navisworks	CEI EnSight EnLiten	ESRI ArcGIS	3DNature RapidForm Polyworks Bentley Microstation 8.1	Scanner Vertice Nova	Corys TESS RAMSIS Powerviz C-Motion Visual 3D Basic	VTK CERV Arevi Coin3D Java3D
SolidWorks eDrawings Viewer Virtools Virtools 3D XE Office Player Icem Viewer Icem Surf	Opticore Revit Architecture Showcase	Intergraph Smart Plant Smart Plant Review	AGI AGI STK AGI STK Viewer	Lattice XVL Player IFC Viewer MADymo Octaga Player Ikea Home Planner Kompas 3D	Unity Cosmo Player	Oil&Gas Roxar RMS Roxar Tempest Tecplot RS	Molecular VMD PyMol Medsumo
Siemens PLM	Adobe Acrobat Adobe 3D Reviewer	Right Hemisphere Deep View Deep Exploration	Google Google Earth Google Sketchup	VAPP Nsided Argile	Scientific VMD Pymol Paraview MeVisLab Celestia MineSet	SIM Reservoir SMT VuPak Geovel	Office Internet Explorer Firefox
JT2GO SolidEdge NX Jack Tecnomatix TeamCenter (VisMockup) RobCAD	RTT RTT DeltaGen RTT DeltaView	Paradigm VoxelGeo 3D Canvas	Landmark Geoprobe SeisWorks StratWorks OpenVision AssetView	Medical Brain Explorer Bone Labs Amira	Avizo VisIT Cloud Compare Fledermaus Matlab AVS	Entertainment Far Cry Doom 3 Quake 4 Second Life	Microsoft Office Mplayer VLC (Videolan) Stereoscopic Player OpenOffice
	Schlumberger Gigaviz Petrel Eclipse	GoCAD GeoDepth					

